

ViewStar Series

RENOGY 10A | 20A | 30A
Pulse Width Modulation Solar Charge Controller Manual



2775 E. Philadelphia St., Ontario CA 91761
1-800-330-8678

Version: 1.0

Important Safety Instructions

Please save these instructions.

This manual contains important safety, installation, and operating instructions for the charge controller. The following symbols are used throughout the manual to indicate potentially dangerous conditions or important safety information.

 **WARNING:** Indicates a potentially dangerous condition. Use extreme caution when performing this task.

CAUTION: Indicates a critical procedure for safe and proper operation of the controller

NOTE: Indicates a procedure or function that is important to the safe and proper operation of the controller.

General Safety Information

- Read all of the instructions and cautions in the manual before beginning the installation.
- There are no serviceable parts for this controller. Do **NOT** disassemble or attempt to repair the controller.
- Do **NOT** allow water to enter the controller.
- Make sure all connections going into and from the controller are tight.

Charge Controller Safety

- **NEVER** connect the solar panel array to the controller without a battery. Battery must be connected first.
- Ensure input voltage does not exceed 48 VDC to prevent permanent damage. Use the Open Circuit (V_{oc}) to make sure the voltage does not exceed this value when connecting panels together.
- Do not exceed 10A (VS1024BN) or 20A (VS2024BN) or 30A (VS3024BN). The Short Circuit (I_{sc}) of the solar array should be less than 10A (VS1024BN) or 20A (VS2024BN) or 30A (VS3024BN).

Battery Safety

- Use only sealed lead-acid, flooded, or gel batteries which must be deep cycle.
- Explosive battery gases may be present while charging. Be certain there is enough ventilation to release the gases.

- Be careful when working with large lead acid batteries. Wear eye protection and have fresh water available in case there is contact with the battery acid.
- Carefully read battery manuals before operation.
- Do **NOT** let the positive (+) and negative (-) terminals of the battery touch each other.
- Recycle battery when it is replaced.
- Over-charging and excessive gas precipitation may damage the battery plates and activate material shedding on them. Too high of an equalizing charge or too long of one may cause damage. Please carefully review the specific requirements of the battery used in the system.
- Equalization is carried out only for non-sealed / vented/ flooded / wet cell lead acid batteries.
- Do **NOT** equalize sealed / VRLA type AGM / Gel cell batteries **UNLESS** permitted by battery manufacturer.

WARNING: Connect battery terminals to the charge controller **BEFORE** connecting the solar panel(s) to the charge controller. **NEVER** connect solar panels to charge controller until the battery is connected.

WARNING: Do **NOT** connect any inverters or battery charger into the load terminal of the charge controller.

WARNING: Once equalization is active in the battery charging, it will not exit this stage unless there is adequate charging current from the solar panel. There should be **NO** load on the batteries when in equalization charging stage.

Table of Contents

General Information	4
Optional Components	6
Identification of Parts	7
Installation	8
Operation	12
1. Monitoring	13
2. Device Set	14
3. Parameter Set	14
4. Load Set	15
6. Test Mode	17
7. Password	17
8. Batt Mng Mode	17
9. Factory Reset	17
10. Reboot Device	18
System Status Icons	18
System Status Glossary	19
System Status Troubleshooting	20
Maintenance	21
Fusing	22
Technical Specifications	23
Electrical Parameters.....	23
Charging Parameters.....	24
Charging Parameters Glossary.....	25
Threshold Voltage Parameters.....	26
Dimensions	27
Wiring Diagrams	30

General Information

The PWM 30ACC-ViewStar is an advanced controller for off-grid solar applications. This high performance PWM charging process is optimized for a long battery life and improved system performance. It can be used for 12V or 24V battery bank. The control is embedded with self-diagnostics and electronic protection functions that prevent damages from installation mistakes or system faults.

Key Features

- Automatic recognition for 12V or 24V battery banks.
- Dot-matrix, backlit LCD for displaying operating information and data.
- Unique dual-timer for the controller's load terminal.
- Full control of parameter settings that can be adjusted.
- Sealed, Gel, and Flooded battery option.
- 4 Stage charging: Bulk, Boost, Float, and Equalization
- Temperature compensation and correcting the charging and discharging parameters automatically, improving battery lifetime.
- RJ45 interface for use with the remote meter MT-50, which conveniently checks the operating parameters of the charge controller
- Protection against: overcharging, over-discharging, overload, short-circuit, and reverse polarity.
- Negative ground controller.

PWM Technology

The PWM 30ACC-ViewStar utilizes Pulse Width Modulation (PWM) technology for battery charging. Battery charging is a current based process so controlling the current will control the battery voltage. For the most accurate return of capacity, and for the prevention of excessive gassing pressure, the battery is required to be controlled by specified voltage regulation set points for Absorption, Float, and Equalization charging stages. The charge controller uses automatic duty cycle conversion, creating pulses of current to charge the battery. The duty cycle is proportional to the difference between the sensed battery voltage and the specified voltage regulation set point. Once the battery reached the specified voltage range, pulse current charging mode allows the battery to react and allows for an acceptable rate of charge for the battery level.

Four Charging Stages

The ViewStar charge controllers have a 4-stage battery charging algorithm for a rapid, efficient, and safe battery charging. They include: Bulk Charge, Boost Charge, Float Charge, and Equalization.

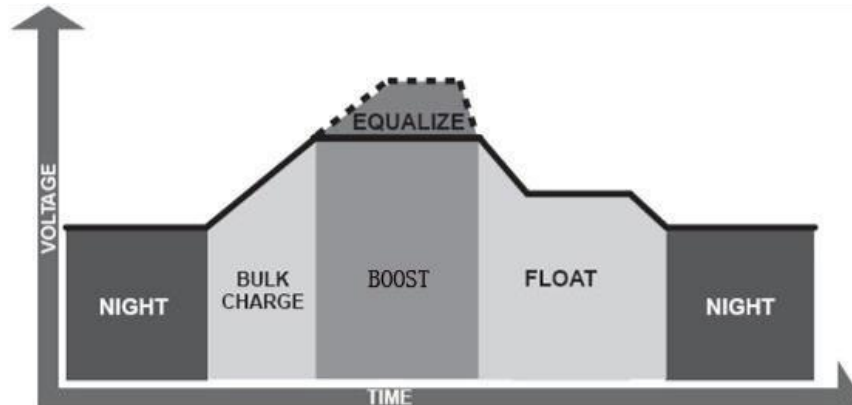

Bulk Charge: This algorithm is used for day to day charging. It uses 100% of available solar power to recharge the battery and is equivalent to constant current.

Boost Charge: When the battery has charged to the Boost voltage set-point, it undergoes an absorption stage which is equivalent to constant voltage regulation to prevent heating and excessive gassing in the battery. The default time for this is 120 minutes in the ViewStar controllers but it can be customizable as needed.

Float Charge: After Boost Charge, the controller will reduce the battery voltage to a float voltage set point. Once the battery is fully charged, there will be no more chemical reactions and all the charge current would turn into heat or gas. Because of this, the charge controller will reduce the voltage charge to smaller quantity, while lightly charging the battery. The purpose for this is to offset the power consumption while maintaining a full battery storage capacity. In the event that a load drawn from the battery exceeds the charge current, the controller will no longer be able to maintain the battery to a Float set point and the controller will end the float charge stage and refer back to bulk charging.

Equalization: Is carried out every 28 days of the month. It is intentional overcharging of the battery for a controlled period of time. Certain types of batteries benefit from periodic equalizing charge, which can stir the electrolyte, balance battery voltage and complete chemical reaction. Equalizing charge increases the battery voltage, higher than the standard complement voltage, which gasifies the battery electrolyte.

WARNING: Once equalization is active in the battery charging, it will not exit this stage unless there is adequate charging current from the solar panel. There should be NO load on the batteries when in equalization charging stage.

WARNING: Over-charging and excessive gas precipitation may damage the battery plates and activate material shedding on them. Too high of equalizing charge or for too long may cause damage. Please carefully review the specific requirements of the battery used in the system.

WARNING: Equalization may increase battery voltage to a level damaging to sensitive DC loads. Ensure that all load allowable input voltages are greater than the equalizing charging set point voltage.

Optional Components

*The PWM10A/20A/30ACC-Viewstar controller is shipped by itself, without any additional components.

Optional components that require a separate purchase:



Figure 1

Remote Temperature Sensor (TS-R): Measures the temperature at the battery and uses this data for very accurate temperature compensation. The sensor is supplied with a 6.6ft cable length that connects to the charge controller. (Figure 1)

NOTE: The 10A/20A/30A-ViewStar controller comes equipped with a temperature sensor, but it is **ONLY** for the charge controller's temperature compensation, not the battery's Temperature compensation.

LCD Display Tracer Meter (MT-50): Allows for real time monitoring of the charge controller. Perfect for circumstances where the user cannot easily access the controller or modify its parameters. It is supplied with a 5.9 ft. cable and a mounting frame that connects to the RJ45 port on the ViewStar. (Figure 2)

External Battery (RTC): Allows for access to the charge controller's saved settings, charge accumulation, and discharge accumulation without connecting a deep cycle marine battery. It keeps track of the date/time for automatic equalization charging purposes.



Figure 2

Identification of Parts

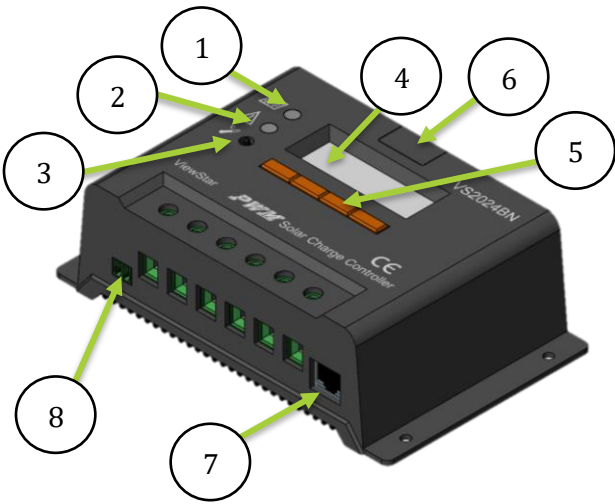

Figure 3: 10A/ 20A ViewStar Model

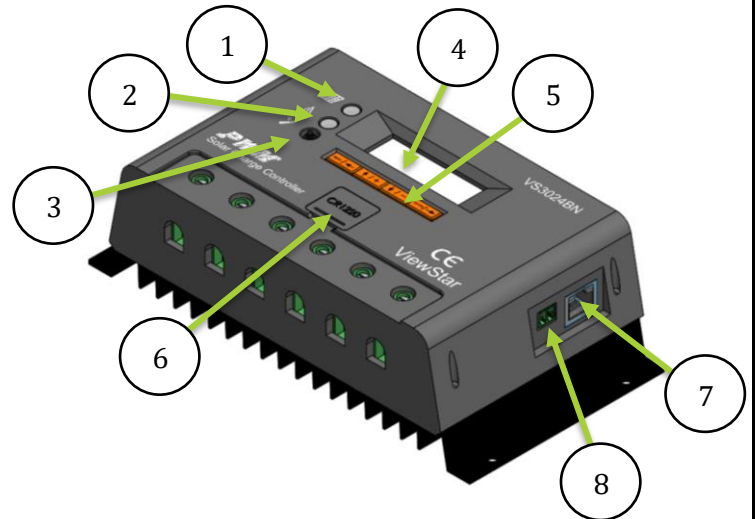

Figure 4: 30A ViewStar Model



Figure 5: 30A ViewStar Model

PV BATTERY LOAD
Terminal Terminal Terminal

Key Parts

1. **Charging LED Indicator**—LED indicator showing charge status.
2. **Fault LED indicator**—LED indicator showing system faults.
3. **Local Temperature Sensor**—acquires ambient temperature to perform temperature compensation for charging and discharging.
4. **Liquid Crystal Display (LCD)**—monitoring interface for solar parameters and system status.
5. **Navigation Buttons**—operate and configure the charge controller.
6. **External battery slot**—mount cell battery (RTC)
7. **RJ45 port for MT-50 Tracer (optional accessory)**—connects remotely to temperature sensor in order to acquire ambient temperature.
8. **TS-R port for Remote Temperature Sensor (optional accessory)**—acquires temperature of the battery to perform temperature compensation.

Installation

Recommended tools to have before installation:



WARNING: Connect battery terminal wires to the charge controller **FIRST** then connect the solar panel(s) to the charge controller. **NEVER** connect solar panel to charge controller before the battery.

WARNING: Do **NOT** connect any inverters or battery chargers into the load terminal of the charge controller.

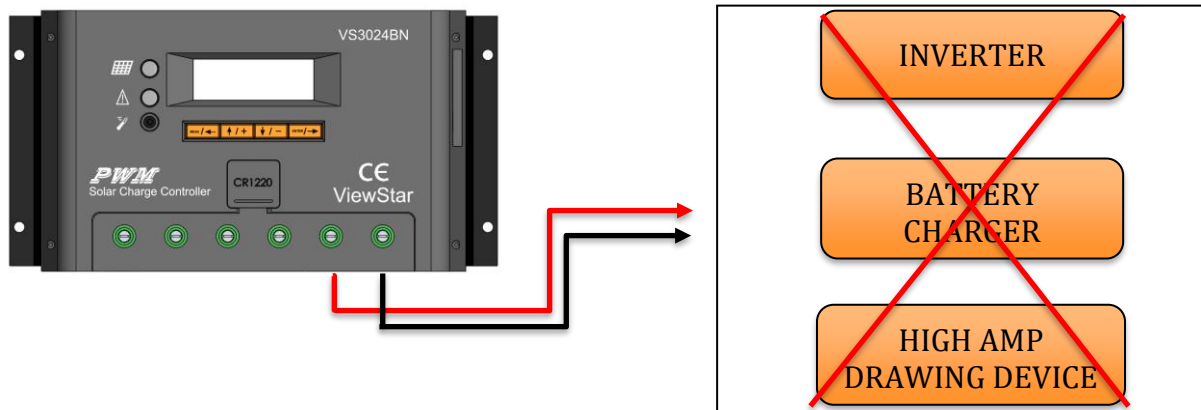

CAUTION: Do not over-torque or over tighten the screw terminals. This could potentially break the piece that holds the wire to the charge controller.

CAUTION: Refer to the technical specifications for max wire sizes on the controller and for the maximum amperage going through wires.

You are now ready to begin connecting your battery to your charge controller.

Battery

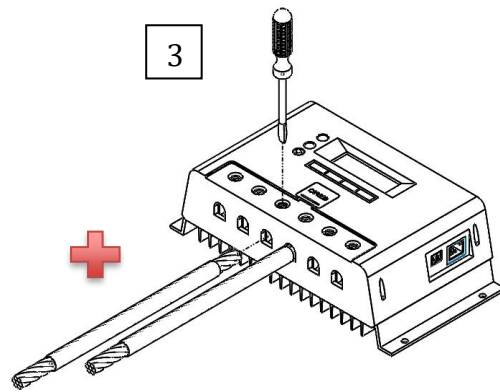
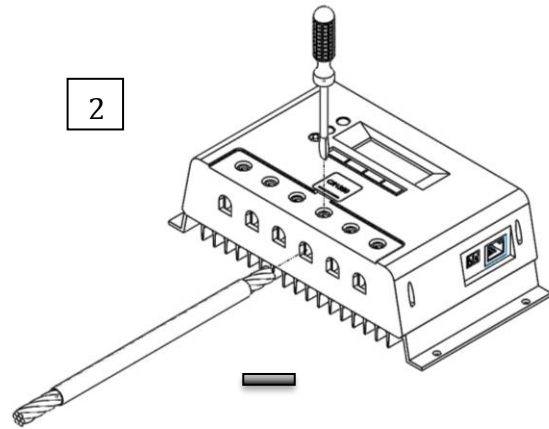
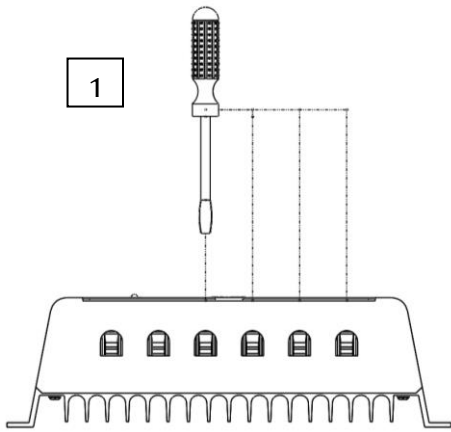

Load (Optional)

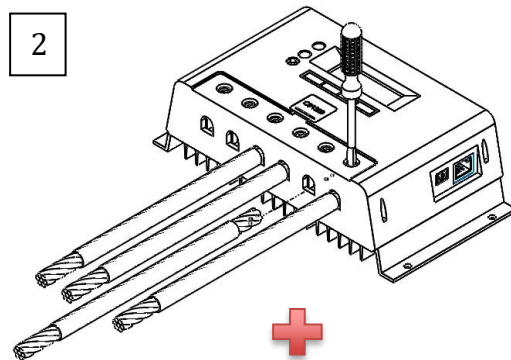
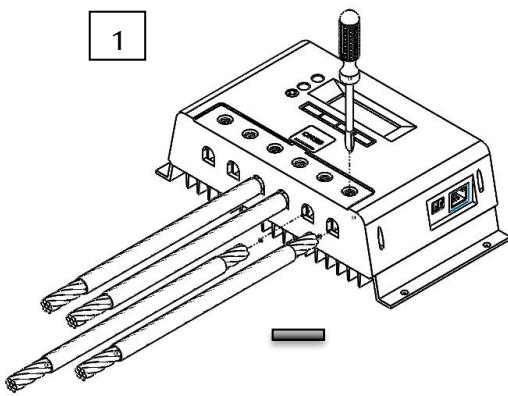

Solar Panels

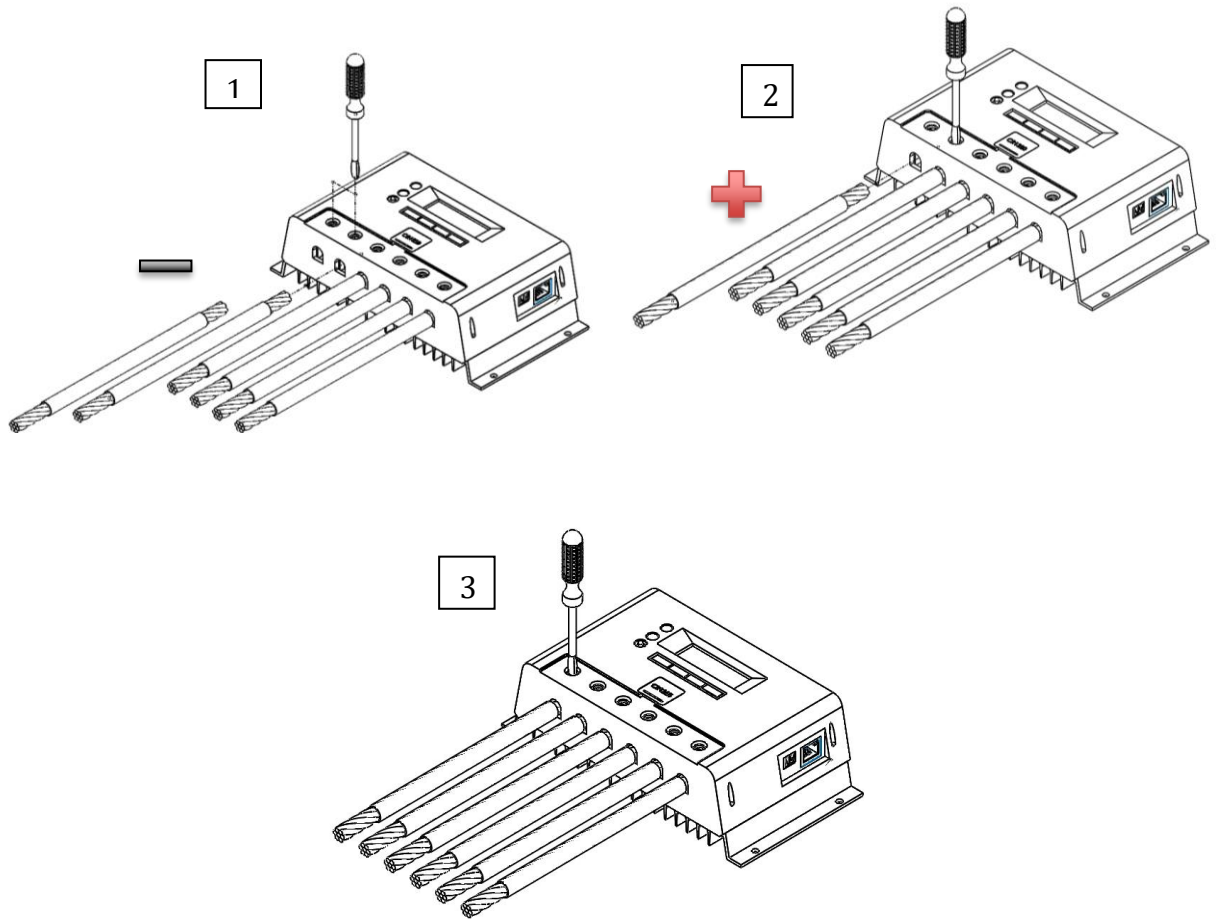

Temperature Sensor (if applicable)

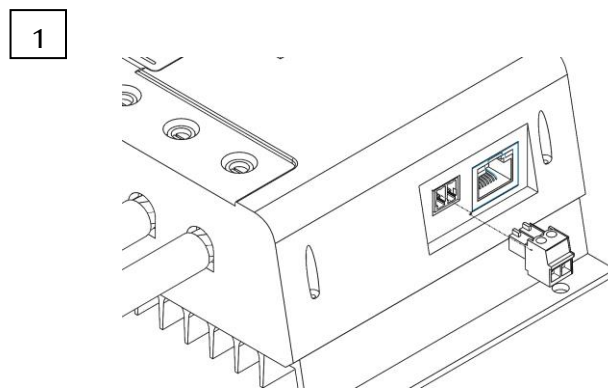

MT-50 Tracer (If applicable)

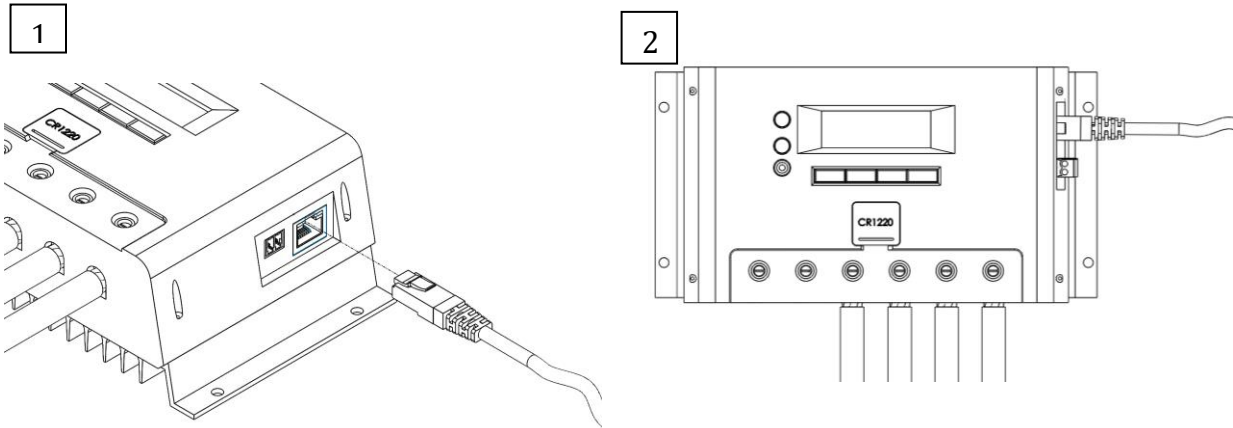

Mounting Recommendations:

WARNING: Never install the controller in a sealed enclosure with flooded batteries. Gas can accumulate and there is a risk of explosion.

1. **Choose Mounting Location**—place the controller on a vertical surface protected from direct sunlight, high temperatures, and water. Make sure there is good ventilation.
2. **Check for Clearance**—verify that there is sufficient room to run wires, as well as clearance above and below the controller for ventilation. The clearance should be at least 6 inches (150mm).
3. **Mark Holes**
4. **Drill Holes**
5. **Secure the charge controller.**

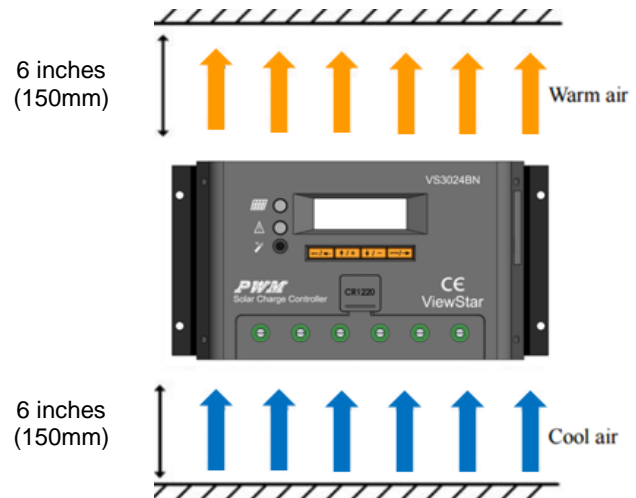



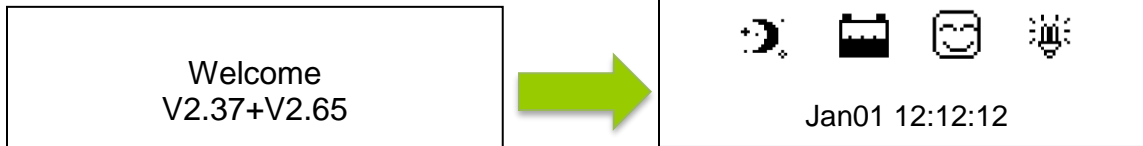

Operation

After connecting the battery to the charge controller, the controller will turn on automatically. The user will be prompted by an initialization screen for a few seconds followed by the Default Screen.



Use the following buttons to maneuver through the menu:

-  Menu / Cursor Left
-  Cursor up / Number add button
-  Cursor down / Number reduce button
-  Enter / Cursor right button

Select  to display the screen selection

1. Monitoring
2. Device Set
3. Parameter Set
4. Load Set
5. Rated Value
6. Test Mode
7. Password
8. Battery Mng Mode
9. Factory Reset
10. Reboot Device

NOTE: In some models, you might be prompted to enter a password. Simply put "0" all the way through and press enter.

NOTE: To customize charge parameters, TYPE must be set to USER under 5. Rated Value.

NOTE: The values found in your controller are default values and will not necessarily match the ones listed. The values on this table are to show the user what the different screens are used for.

NOTE: You do **NOT** have to program the control. These parameters are for extra features. Once you connect the battery the settings are automatically synced.

1. Monitoring

Use   to maneuver through the screens

PV
0.0V 0.0A

Indicates the voltage (V) and amperage (A) that the solar panel(s) are delivering to the controller

BATT
12.5V 0.0A

Indicates the voltage (V) and amperage (A) that the solar panel(s) are delivering to the battery

TEMP 20.0 C °
SOC 7%

Indicates the ambient temperature as well as the SOC (State of charge) of the battery

NOTE: The SOC% is an estimation based on the charging voltage.

LOAD
12.5V 0.0A

Indicates Load voltage (V) and amperage (A) draw

PV: Disconnect
BATT: NoCharge/ Normal
LOAD: On
DEVICE: Normal

System status of components—PV panels, Battery status, Load status, and Device functionality. Refer to **System Status Glossary** for more information

Charg. Energy
Day: 0.00kWh
Mon: 0.00kWh
Total: 0.00kWh

The kilowatt hours accumulated in a day, Month, and total since the controller has been turned on

NOTE: Once the battery is disconnected, the values are reset to 0 unless there is an external battery installed on the controller face

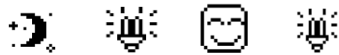

Jan01 12:12:12

System status icons, date, and time. Refer to **System Status Icons** for more information

2. Device Set

Use   to cycle through the screens. Press  to select

Device Set
Date: 00-00-0000
Time: 00:00:00

Modify the date and time for the charge controller. Time is displayed in military time (24Hr) and will be reflected in the default screen. Select Save when finished. The user will have to select save parameters after every screen.

Save Parameters?
> Save Cancel

Device Set
ID: 001
Backlit: 000 sec

Modify the time the backlight is on for the charge controller. Backlit operation is in effect once the last button is pressed. The user could use the ID to connect to a tracer meter and save parameters. Select Save Parameters when finished.

Device Set
Temp Unit:
> Cel Fah

Choose between Celsius or Fahrenheit when viewing system status temperature.

3. Parameter Set

NOTE: To customize charge parameters, TYPE must be set to USER under 5. Rated Value. Otherwise this screen is only for information in regards to the charge parameters.

NOTE: Minimum and maximum charge parameter values can be found in Technical Specifications

Parameter Set
Temp Compensate Coeff
-03.0 mV / C ° / 2V

Indicates Temperature Compensation. Temperature fluctuation can affect performance in the system. Therefore, the purpose of temperature compensation is to adjust the performance of the system to keep the system functioning normally.

Parameter Set
Over Vol. Disc: 16.0V
Charg Lmt: 15.0V
Over Volt. Rect: 15.0V

Parameters for Over-Voltage Disconnect, Charging Limit, and Over-Voltage Reconnection.

Parameter Set
Equal Chrg: 14.6V
Boost Chrg: 14.4V
Float Chrg: 13.8V

Parameters for commencing Equalization Charging, Boost Charging, and Float Charging.

Parameter Set
Boost V. Rect: 13.2 V
Under V. Rect: 12.2 V
Under V. Warn: 12.0 V

Parameters for Boost Voltage Reconnect, Boost Under-Voltage Reconnect, and Boost Under-Voltage warning.

Parameter Set
Low V. Rect: 12.6V
Low V. Disc: 11.1V
Discharg Lmt: 10.6V

Parameters for controller Low Voltage-Reconnect, Low Voltage-Disconnect, and the Discharge Limit.

Parameter Set
Equa. Time: 120Min
Boost Time: 120Min

Parameter for setting a time duration for when the controller approaches Equalization Charging and Boost Charging.

4. Load Set

Use   to cycle through the screens. Press  to select

Manual
Light On/Off
Light On+Timer
Timer

A load selection menu allows the user to control the load terminal activation automatically, manually, or with a timer.

Manual Default
>ON OFF

This function will set the controller to manual mode by default so the user is able to control when to turn the load on or off.

NOTE: The user will need to set delay time to "0" so that manual mode can be instant as opposed to waiting for the delay time to pass.

Manual
Light On/Off
Light On+Timer
Time

Light On/Off
On: **0**5.0V Delay: 10m
Off: 06.0V Delay: 10m

Light On + Timer
On: **0**5.0V Delay: 10m
Off: 06.0V Delay: 10m
Night Time: 12:00

Time Control 1
On Time: **1**9:00:00
Off Time: 06:00:00

In Light On/Off, the user sets parameters to turn the load on or off.

The load terminal automatically turns on when the solar voltage goes BELOW the point of NTTV (Night Time Threshold Voltage). The load automatically turns off when the voltage goes ABOVE the point of DTTV (Day Time Threshold Voltage). There is a delay between turning the load on or off and can be programmed to be from 0-99minutes.

NOTE: Minimum and maximum charge parameter values can be found in Technical Specifications

Similar to Light On/Off parameter with the addition of a timer that the user sets in order to indicate how long a load will be on or off. The user also sets an appropriate time for when it is night time.

NOTE: Timer needs to be activated for it to work.

Using a 24-hour clock, the user is able to set the time for when the load will turn on and the time for when the load will turn off.

5. Rated Value

Use   to cycle through the screens. Press  to select

NOTE: To customize charge parameters, BATT must be set to USER

Rated Value
Batt: **AUTO** 0200AH
Load: 20.0A PV:20.0A
Type: Seal

For BATT: the user selects which battery describes the one they have—12V, 24V, or AUTO

For Type: The user chooses from Gel, Sealed, Flooded or USER

The user is able to modify the Amp-hours (AH) to reflect the actual battery capacity.

NOTE: The Load and PV options will not be adjustable since the value is based on the charge controller.

6. Test Mode

Use   to cycle through the screens. Press  to select

Test Mode
Load: > **ON** OFF

Test the load of the charge controller. Once settings have been set in 4. Load Set, the user is able to test whether the load will turn on upon direction.

NOTE: Delay must be set to “0” to see immediate results.

7. Password

Use   to cycle through the screens. Press  to select

Password
Ori.PSW: 000000
NewPSW: 000000

Setting a password for the controller prohibits the user from programming the controller unless the password is set.

NOTE: Default Password is “00000” if it prompts the user to enter a password before they set one.

8. Batt Mng Mode

Use   to cycle through the screens. Press  to select

Batt Mng Mode
> **V.C.** SOC

Voltage Compensation and State of Charge Battery Managing modes to determine battery charge status.

NOTE: It is not possible to measure actual SOC, but rather express it as a percentage of some reference. In this case it is voltage alone (VC) or battery capacity over a time span (SOC).

VC. converts a reading from battery voltage to determine SOC by utilizing the charge controller’s algorithm for known discharge. It is highly sensitive to temperature changes and battery disturbances thus having less accurate battery charge statuses.

SOC is more accurate by keeping track of the voltage and current flow in and out of the battery when reporting battery charge status. The SOC is determined by multiplying current by the time for which it flowed.

9. Factory Reset

Use   to cycle through the screens. Press  to select

Factory Reset
> NO **YES**

Reset the controller to factory settings. This will erase any customized parameters the user may have set.

Really to reset?
 >NO YES

The screen will be followed up by a secondary screen to make sure a factory reset is what the user intends to do.

10. Reboot Device











Use   to cycle through the screens. Press  to select

Reboot Device?
 >NO YES

This parameter will reboot the charge controller without losing any of the customized settings the user may have set.

System Status Icons





PV	BATTERY	SYSTEM	LOAD
			
Day/ PV Charging	Battery Charging	System Normal	Load ON
			
Night/ PV Not Charging	Battery Level Full	UVW	Load OFF
			
	Battery Low Voltage	LVD	





System Status Glossary

PV: Disconnect
 BATT: NoCharge/ Normal
 LOAD: On
 DEVICE: Normal







PV Status	Meaning
Connect	PV is Connected
Disconnect	PV is Disconnected
Measure Err	Measurement Error at the PV terminal
Over Current	PV is Overcurrent
MOS-I Short	(Metal oxide semiconductor) used for PV reverse polarity is short.
MOS-C Short	(Metal oxide semiconductor) used for charging is short.
MOS Break	(Metal oxide semiconductor) in control circuit is damaged
BATT Status	Meaning
Equalize	Battery is equalizing
Boost	Battery is in boost mode
Float	Battery is in float mode
NoCharge	No charge to battery
LVD	Low voltage disconnect
UVW	Under voltage warning
Normal	Battery is normal
OVD	Over voltage disconnect
Error	Battery experiencing error
OverTemp	Battery is too hot, over temperature
LOAD Status	Meaning
On	Load On
Off	Load Off
Overload	Load is overloaded
Short	Load connection is short
Error	Load experiencing error
MOS Short	Metal oxide semiconductor used in load is short
DEVICE Status	Meaning
Normal	Charge controller normal
OverTemp	Charge controller too hot

System Status Troubleshooting

Indicator	Status	Description	Troubleshoot
	Connect	The controller recognizes the PV solar panel(s). System is functioning normally.	N/A
	Disconnect	The controller does not recognize the solar panel(s).	If it is nighttime, the light will be off. Otherwise double check that the poles are not switched.

Indicator	PV Status	Troubleshoot
	Measure Err	Check connections and make sure there is not a short somewhere along the line. Use a multi-meter to determine whether the panel(s) output is normal prior to connection. Then reset the controller to factory settings.
	OverCurrent	Use a multi-meter to determine whether solar panel(s) specification match the nominal parameters of the charge controller.
	MOS-I Short	Reset the controller to factory settings. If problem persists, contact the supplier
	MOS-C Short	Reset the controller to factory settings. If problem persists, contact the supplier
	MOS Break	Reset the controller to factory settings. If problem persists, contact the supplier

Indicator	BATT Status	Troubleshoot
	Error	Check that the battery connections are properly connected to the battery terminals of the charge controller. Make sure there is no short along the line. Reboot the controller. If problem continues, reset the controller.

	OverTemp	Place the controller in a cooler environment where it will automatically reconnect.
	OVD	Check battery parameters and make sure they are suitable to be used with the charge controller. Use a multi-meter to check battery voltage to reaffirm the controller's diagnosis.
Indicator	LOAD Status	Troubleshoot
	Overload	Check to make sure the devices connected to the load terminal are within the load specification. If so, then reduce the number of loads and it will reconnect automatically.
	Short	Check the device wiring and connections going into the load. There may be a break in the wire.
	Error	Reset the controller to factory settings. If problem persists, contact supplier.
	MOS Short	Reset the controller to factory settings. If problem persists, contact supplier.
Indicator	Device Status	Troubleshoot
	OverTemp	Place controller in cooler environment and it will automatically reconnect.

Maintenance

For best controller performance, it is recommended that these tasks be performed from time to time.

1. Check that controller is mounted in a clean, dry, and ventilated area.
2. Check wiring going into the charge controller and make sure there is no wire damage or wear.
3. Tighten all terminals and inspect any loose, broken, or burnt up connections
4. Make sure readings in the LCD and LED are consistent.

Fusing

Fusing is recommended in PV systems to provide a safety measure for connections going from panel to controller and controller to battery. Remember to always use the recommended wire gauge size based on the PV system and the controller.

NEC Maximum Current for different Copper Wire Sizes									
AWG	16	14	12	10	8	6	4	2	0
Max. Current	10A	15A	20A	30A	55A	75A	95A	130A	170A

Fuse from Controller to Battery

Controller to Battery Fuse = Current Rating of Charge Controller

Ex. 30A ViewStar CC = 30A fuse from Controller to Battery

Fuse from Solar Panel(s) to Controller

Ex. 200W; 2 X 100 W panels

Series:

Total Amperage = $I_{sc1} = I_{sc2} = 5.75A * 1.56$

Fuse = minimum of $5.75A * 1.56 = 8.97A = \underline{9A \text{ fuse}}$

Parallel

Total Amperage = $I_{sc1} + I_{sc2} = (5.75A + 5.75A) * 1.56$

Fuse = minimum of $11.5 * 1.56 = 17.94 = \underline{18A \text{ fuse}}$

Technical Specifications

Electrical Parameters

Model	VS1024BN	VS2024BN	VS3024BN
Nominal system voltage	12V/24V auto recognition		
Rated battery current	10A	20A	30A
Rated load current	10A	20A	30A
Max. battery voltage	32V		
Max. Solar Input	48V		
Equalize charging voltage	Sealed: 14.6V, Flooded: 14.8V, User-defined: 9~17V		
Boost charging voltage	Gel: 14.2V, Sealed: 14.4V, Flooded: 14.6V, User-defined: 9~17V		
Float charging voltage	Gel /Sealed /Flooded: 13.8V, User-defined: 9~17V		
Low voltage reconnect voltage	Gel /Sealed /Flooded: 12.6V, User-defined: 9~17V		
Low voltage disconnect voltage	Gel /Sealed /Flooded: 11.1V, User-defined: 9~17V		
Self-consumption	≤15mA(12V); ≤10mA(24V);		
Grounding	Common negative		
Temp. compensation	-3mV/°C/2V		
Relative humidity	10%~90% Non-condensation		
Communication	RS485 / RJ45 interface		
LCD temperature	-20°C ~ +70°C		
Working temperature	-25°C ~ +55°C		
Humidity	≤95% N.C.		
Enclosure	IP30		
Overall dimension	6.38x3.35x1.57inch (162x85x40mm)	6.38x3.94x1.97inch (162x100x50mm)	7.87x4.05x2.28inch (200x103x58mm)
Terminals	4mm ² (Up to #12 AWG)	10mm ² (Up to #8 AWG)	16mm ² (Up to #6 AWG)
Net weight	0.66 lbs. (0.3kg)	0.88 lbs. (0.4kg)	1.54 lbs. (0.7kg)
Battery Type	Gel, Sealed (AGM), and Flooded		

Charging Parameters

NOTE: Under the USER battery setting, the parameters can be adjusted within the boundaries of the max and min values listed below.

Parameter	Battery type	Gel	Sealed	Flooded
High Volt Disconnect (Over-voltage disconnect)	Default	16.0V; x2/24V	16.0V; x2/24V	16.0V; x2/24V
	Max	17.0V; x2/24V	17.0V; x2/24V	17.0V; x2/24V
	Min	15.0V; x2/24V	15.0V; x2/24V	15.0V; x2/24V
Charging Limit Voltage	Default	15.0V; x2/24V	15.0V; x2/24V	15.0V; x2/24V
	Max	16.0V; x2/24V	16.0V; x2/24V	16.0V; x2/24V
	Min	14.0V; x2/24V	14.0V; x2/24V	14.0V; x2/24V
Over Voltage Reconnect	Default	15.0V; x2/24V	15.0V; x2/24V	15.0V; x2/24V
	Max	16.0V; x2/24V	16.0V; x2/24V	16.0V; x2/24V
	Min	14.0V; x2/24V	14.0V; x2/24V	14.0V; x2/24V
Equalization Voltage	Default	N/A	14.6V; x2/24V	14.8V; x2/24V
	Max	N/A	15.2V; x2/24V	15.2V; x2/24V
	Min	N/A	14.2V; x2/24V	14.2V; x2/24V
Boost Voltage	Default	14.2V; x2/24V	14.4V; x2/24V	14.6V; x2/24V
	Max	15V; x2/24V	15V; x2/24V	15V; x2/24V
	Min	13.8V; x2/24V	13.8V; x2/24V	13.8V; x2/24V
Float Voltage	Default	13.8V; x2/24V	13.8V; x2/24V	13.8V; x2/24V
	Max	14.2V; x2/24V	14.2V; x2/24V	14.2V; x2/24V
	Min	13.2V; x2/24V	13.2V; x2/24V	13.2V; x2/24V
Boost Return Voltage	Default	13.2V; x2/24V	13.2V; x2/24V	13.2V; x2/24V
	Max	13.5V; x2/24V	13.5V; x2/24V	13.5V; x2/24V
	Min	12.7V; x2/24V	12.7V; x2/24V	12.7V; x2/24V
Low Voltage Reconnect	Default	12.6V; x2/24V	12.6V; x2/24V	12.6V; x2/24V
	Max	12.9V; x2/24V	12.9V; x2/24V	12.9V; x2/24V
	Min	12.3V; x2/24V	12.3V; x2/24V	12.3V; x2/24V
Under Voltage Recover	Default	12.2V; x2/24V	12.2V; x2/24V	12.2V; x2/24V
	Max	12.6V; x2/24V	12.6V; x2/24V	12.6V; x2/24V
	Min	11.8V; x2/24V	11.8V; x2/24V	11.8V; x2/24V
Under Voltage Warning	Default	12.0V; x2/24V	12.0V; x2/24V	12.0V; x2/24V
	Max	12.4V; x2/24V	12.4V; x2/24V	12.4V; x2/24V
	Min	11.6V; x2/24V	11.6V; x2/24V	11.6V; x2/24V
Low Voltage Disconnect	Default	11.1V; x2/24V	11.1V; x2/24V	11.1V; x2/24V
	Max	11.8V; x2/24V	11.8V; x2/24V	11.8V; x2/24V
	Min	10.5V; x2/24V	10.5V; x2/24V	10.5V; x2/24V
Discharging Limit Voltage	Default	10.6V; x2/24V	10.6V; x2/24V	10.6V; x2/24V
	Max	11V; x2/24V	11V; x2/24V	11V; x2/24V
	Min	10.5V; x2/24V	10.5V; x2/24V	10.5V; x2/24V
Equalize Duration	N/A	N/A	2 hours	2 hours
Boost Duration	N/A	2 hours	2 hours	2 hours

NOTE: The following rules **MUST** be obliged when setting custom parameters.

Rule 1: High Volt Disconnect > Charging limit voltage \geq Equalization voltage \geq Boost voltage \geq Float voltage > Boost return voltage;

Rule 2: High Volt Disconnect > Over Voltage Reconnect;

Rule 3: Charging Limit Voltage > Low voltage reconnect > Low voltage disconnect;

Rule 4: Charging Limit Voltage > Under voltage recover > under voltage warning;

Rule 5: Boost return voltage > Low voltage reconnect;

Charging Parameters Glossary

High Volt Disconnect—users can use the default parameters or assign a rated voltage value that the charge controller will operate. When and if the charge controller experiences a voltage higher than what is assigned, it will disconnect itself from the circuit; ceasing charge.

Charging Limit Voltage—depending on the batteries used, there might be a battery charging limit voltage that is recommended for the battery. This parameter ensures that the charge controller does not exceed the default or assigned rated charging limit voltage. This is usually put into play to optimize and extend the life of the battery. Relatively speaking, the higher the charging voltage then there is a correlation for reduced battery efficiency. (Likewise the lower the discharge voltage affects battery efficiency.

Over-voltage Reconnect—In the event a charge controller experiences an over-voltage condition set by the previous two parameters, then this reconnecting parameter is put into play to direct the controller when it can connect and safely charge again. Typically over-voltage reconnection is achieved when time has passed (ex. The sun setting), or when the over-voltage condition is remedied ultimately reducing the voltage to a user defined charging voltage.

Equalization Voltage—equalization voltage is a corrective over-charge of the battery. The user should consult their battery manufacturer regarding specific battery equalization capacity. This parameter sets the equalization voltage to set the battery at when it reaches the equalization state.

Boost Voltage—users should check with their battery manufacturer for proper charging parameters. In this stage, users set the boost voltage where the battery will reach a voltage level and remain there until the battery undergoes an absorption stage

Float Voltage—once the charge controller recognizes the set float voltage, it will commence floating. The battery is supposed to be fully charged in his state, and the charge current is reduced to maintain battery stability levels.

Boost Return Voltage—if at any point, the battery voltage levels registers to be below the boost return voltage for an extended period amount of time, then the charge controller will commence the boost stage once again.

Low Voltage Reconnect—this parameter allows loads connected to the system will be able to operate (not fully) again.

Under-voltage Recover—deals with the loads connected to the system. When batteries are determined to be low due to them approaching low voltage disconnect, then the loads will be shut off to give the batteries time to recover. This parameter sets the controller to shut off the loads until it can reach the low voltage reconnect stage.

Under-voltage Warning—this parameter deals with the batteries themselves approaching the under-voltage recovery state. The user should minimize loads before the charge controller approaches a level where it will do this automatically to protect the battery from discharging

Low-voltage disconnect—prevents over-discharge of the batteries by automatically disconnecting any loads. This extends battery life and is the precedent to being in an under voltage state, recovering from the under voltage state, and finally reconnecting to normal operational state.

Discharging limit Voltage—the user can set the “discharge” limit of a battery if they choose to better protect the battery and expand its life. The following chart serves as an example of voltages and their state of charges. Note that the higher the charging limit and lower the discharge limit correlates with overall low battery life.

State of Charge	12 V Battery	Volts per Cell
100%	12.7	2.12
90%	12.5	2.08
80%	12.42	2.07
70%	12.32	2.05
60%	12.20	2.03
50%	12.06	2.01
40%	11.9	1.98
30%	11.75	1.96
20%	11.58	1.93
10%	11.31	1.89
0	10.5	1.75

Threshold Voltage Parameters

The following chart demonstrates the parameters when using the Timer under load settings.

Description	Parameter	
	Default	5V; x2/24V
Day Time Threshold Voltage (DTTV)	Max	10V; x2/24V
	Min	1V; x2/24V
	Default	6V; x2/24V
Night Time Threshold Voltage (NTTV)	Max	10V; x2/24V
	Min	1V; x2/24V
	Default	6V; x2/24V

Dimensions

10A VS1024BN

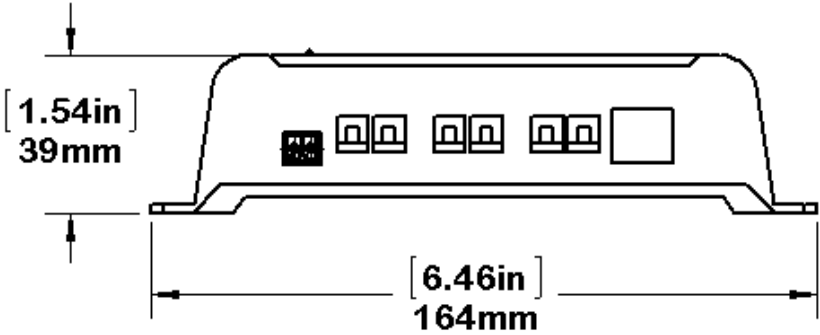
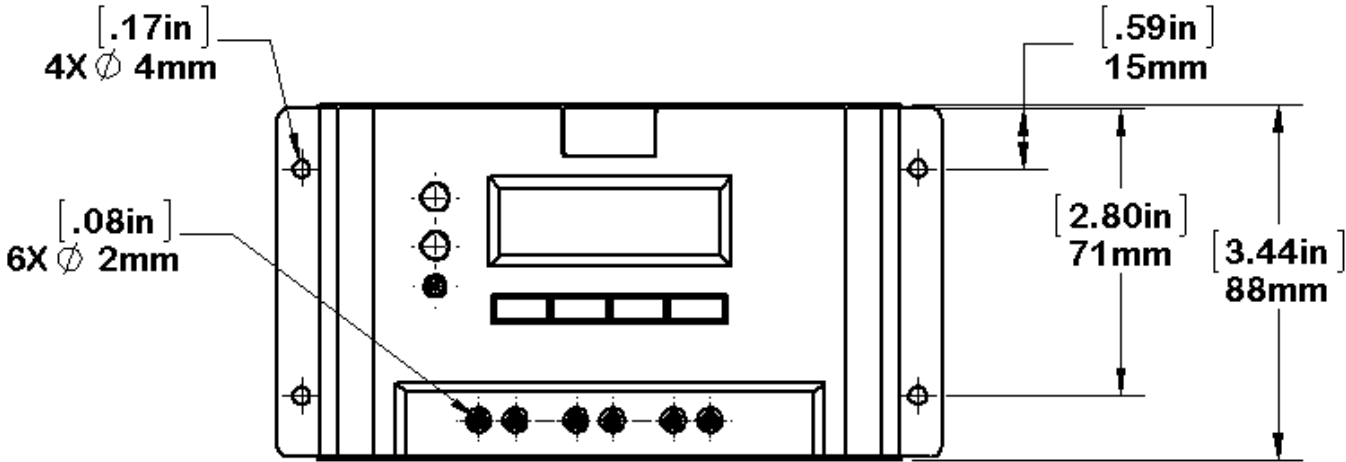

20A VS2024BN

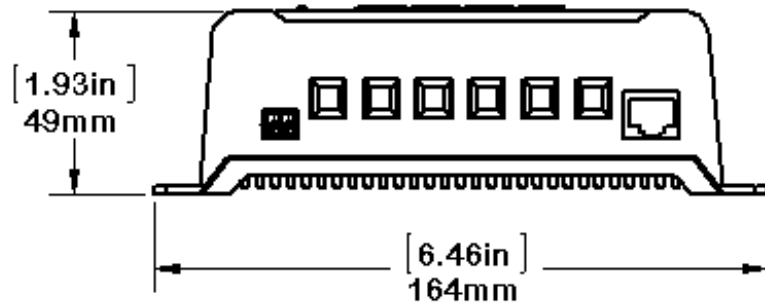
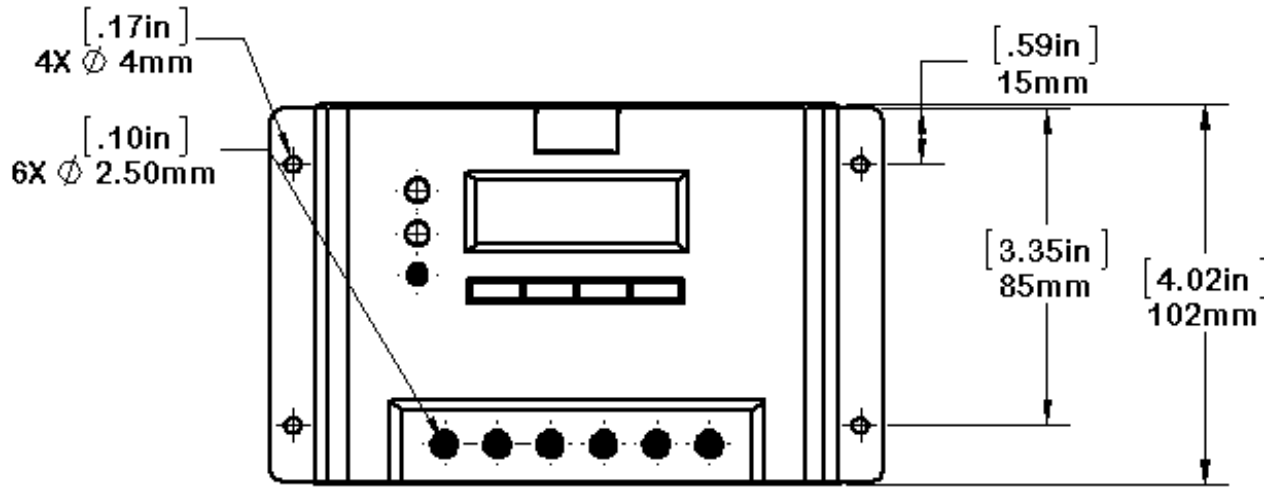

30A VS3024BN

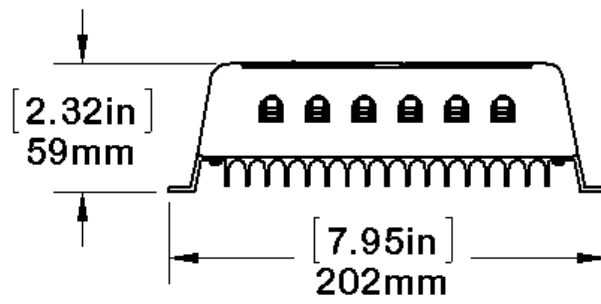
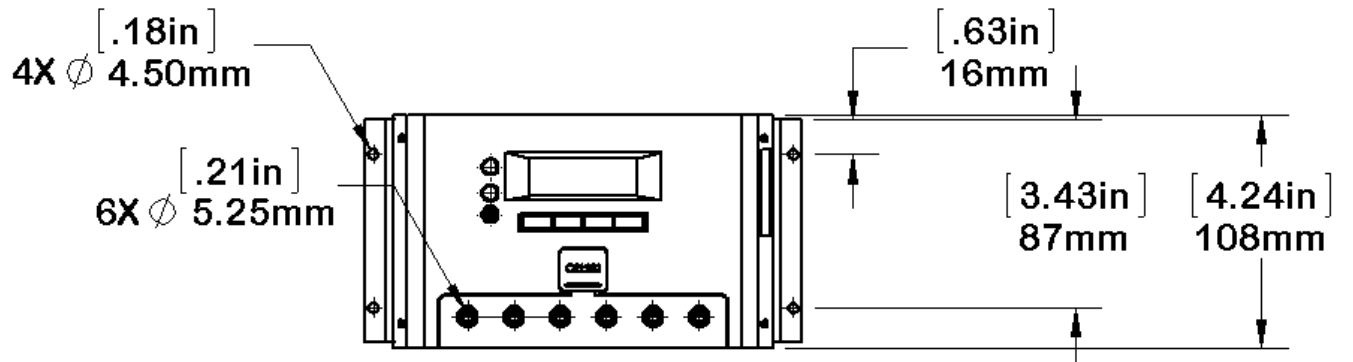

Wiring Diagrams



100W Wiring Diagram 12V Battery Bank

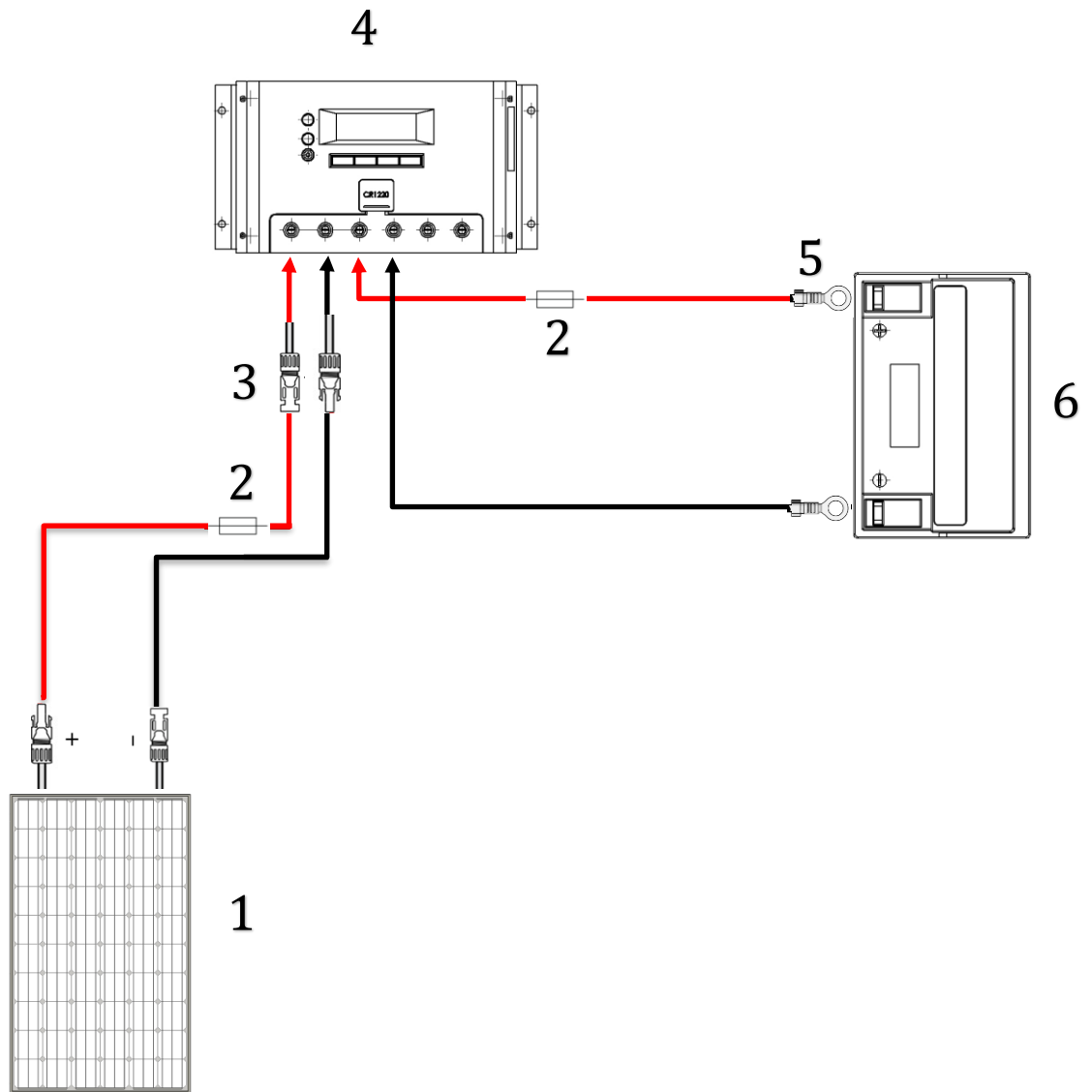

1. Solar Panel

4. Charge Controller (10A/20A/30A),

2. Fuse

5. Tray Cable

3. Adapter Kit

6. Battery Bank (12V)

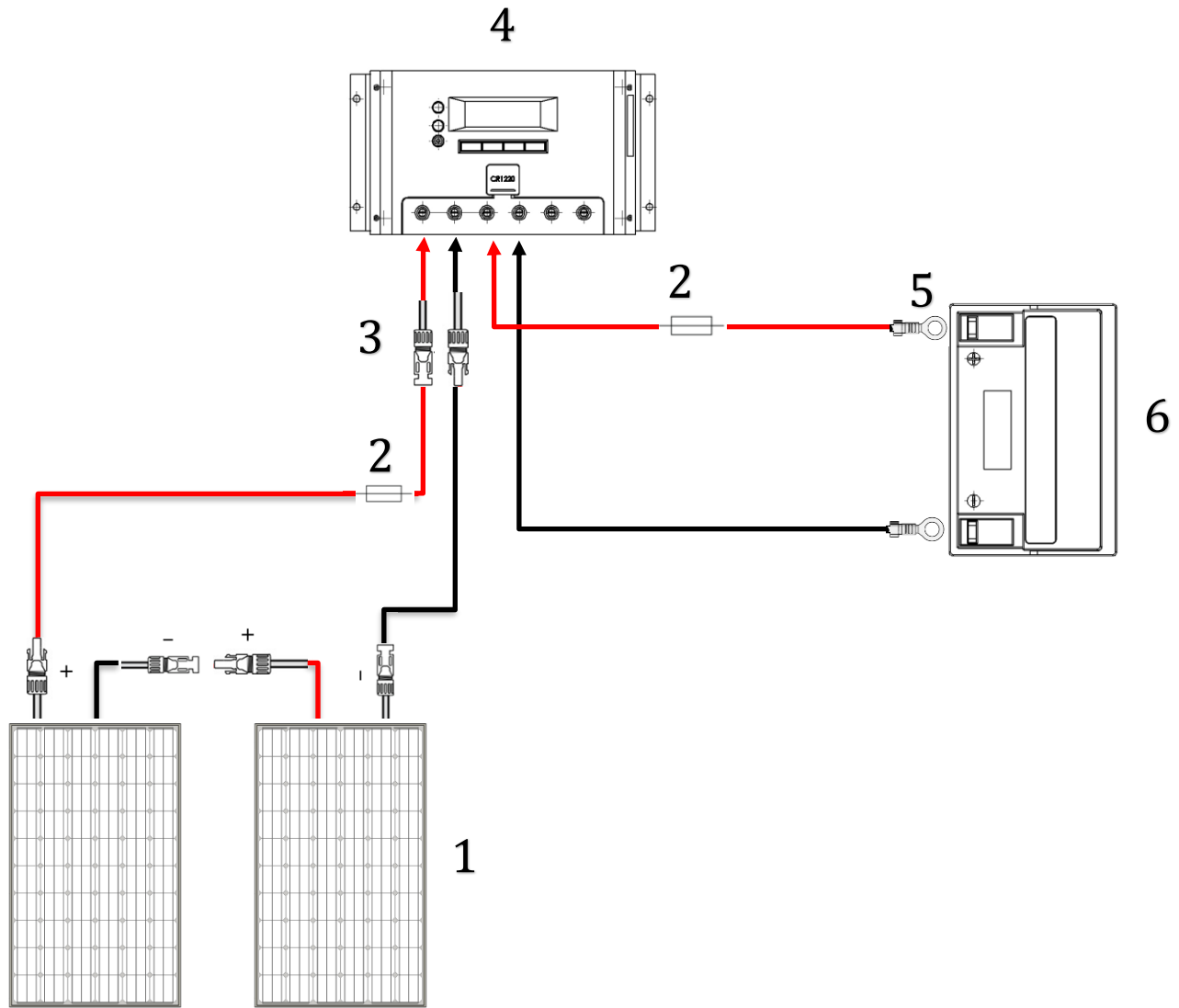

1. Solar Panels
4. Charge Controller (20A/30A),

2. Fuse
5. Tray Cable

3. Adapter Kit
6. Battery Bank (12V)

**200W Wiring Diagram—Parallel
12V Battery Bank**

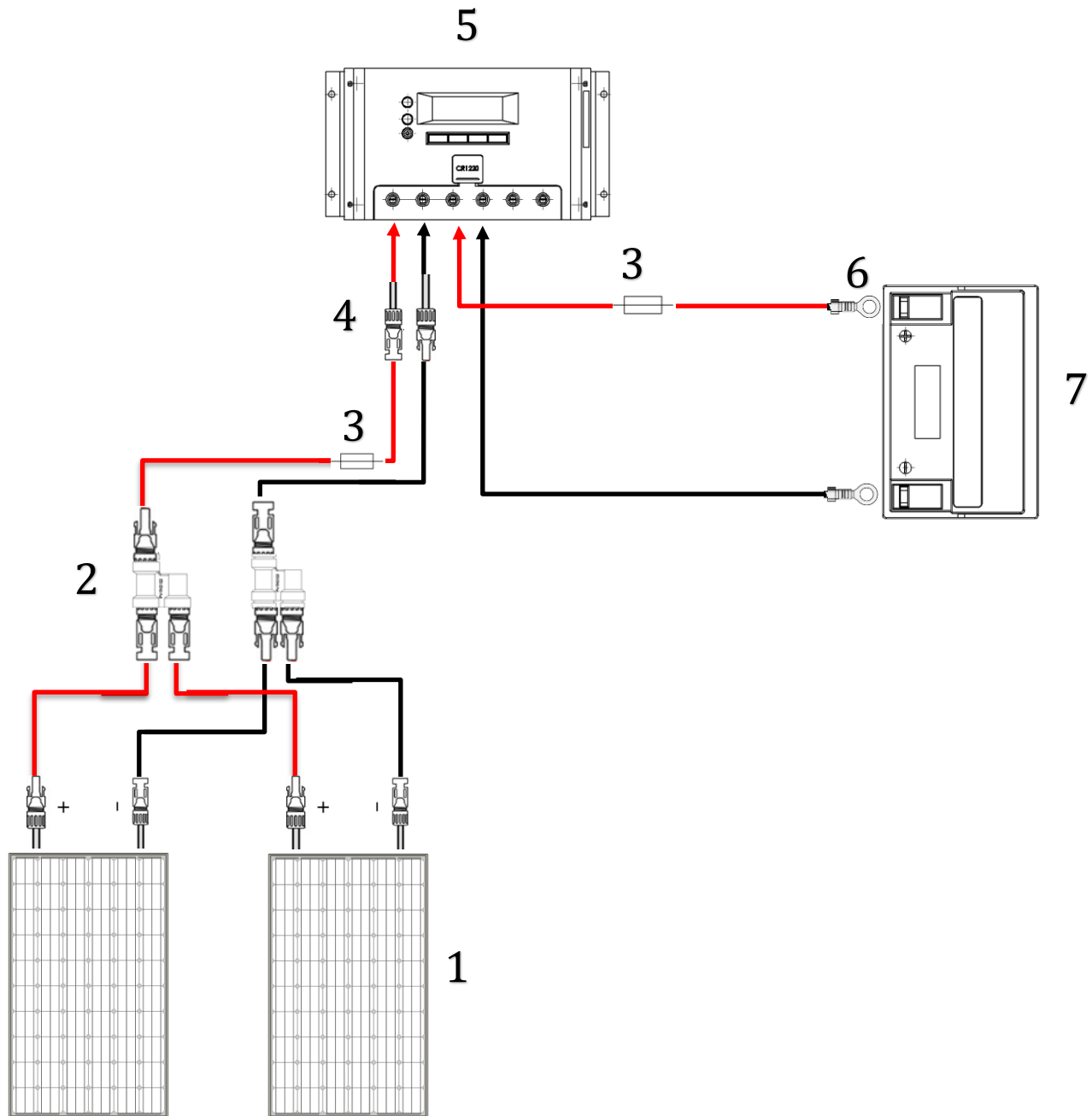

- 1. Solar Panels
- 2. MC4 Branch Connectors
- 3. Fuse
- 4. Adapter Kit
- 5. Charge Controller (20A/30A)
- 6. Tray Cable
- 7. Battery Bank (12V)

**300W Wiring Diagram—Parallel
12V Battery Bank**

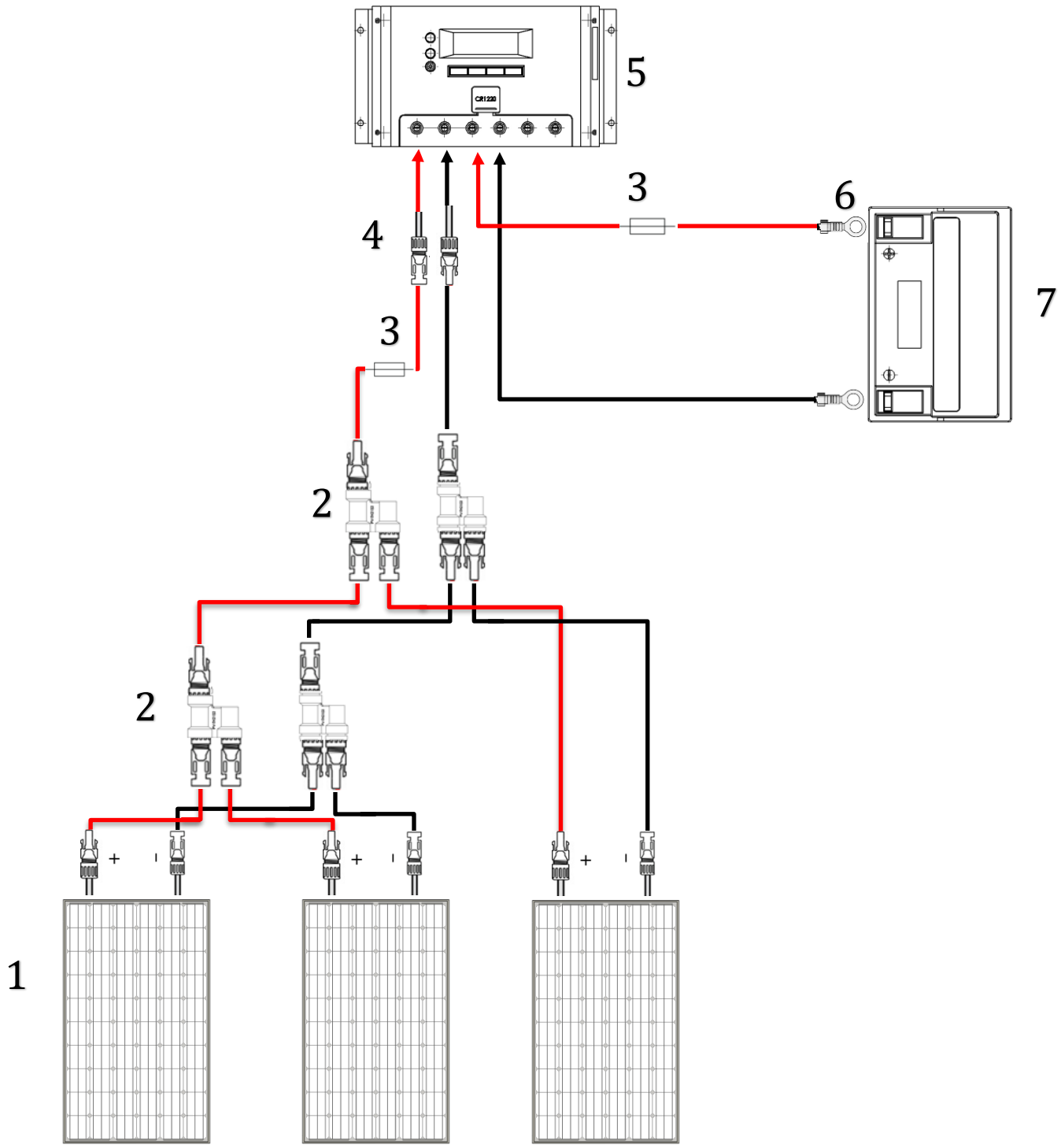

- 1. Solar Panels
- 2. MC4 Branch Connectors
- 3. Fuse
- 4. Adapter Kit
- 5. Charge Controller (30A)
- 6. Tray Cable
- 7. Battery Bank (12V)

**400W Wiring Diagram—Parallel
12V Battery Bank**

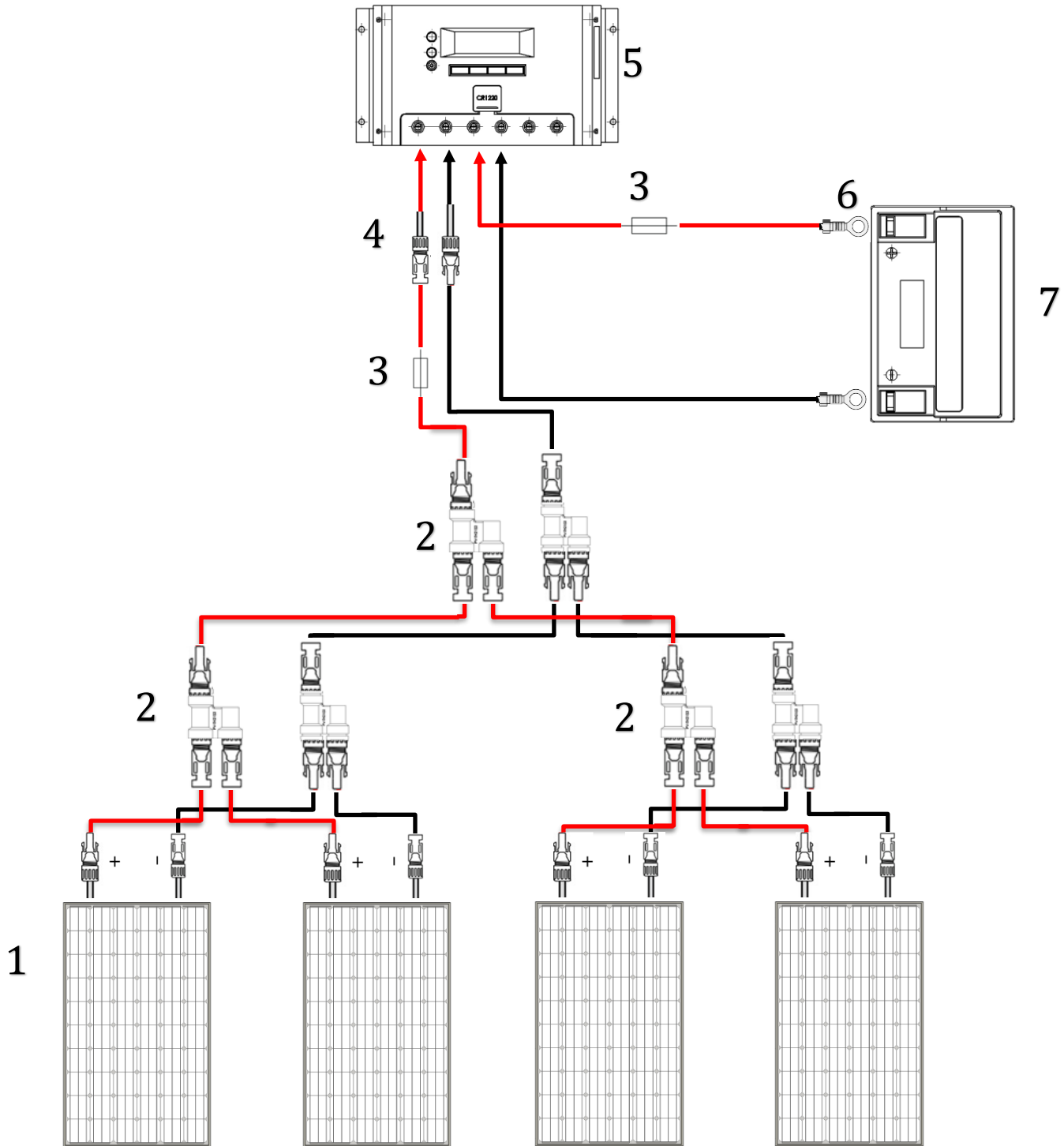

- 1. Solar Panels
- 2. MC4 Branch Connector
- 3. Fuse
- 4. Adapter Kit
- 5. Charge Controller (30A),
- 6. Tray Cable
- 7. Battery Bank (12V)